

Optima_TFmaxi_Serie_2019-202	
0_1	
H_Schaltplan_Zylinderhydraulik	
Machine Number: from 0000	
Last change date 27.03.2018	Drafter JMO
Date 1. creation 26.05.2009	Designer FSC

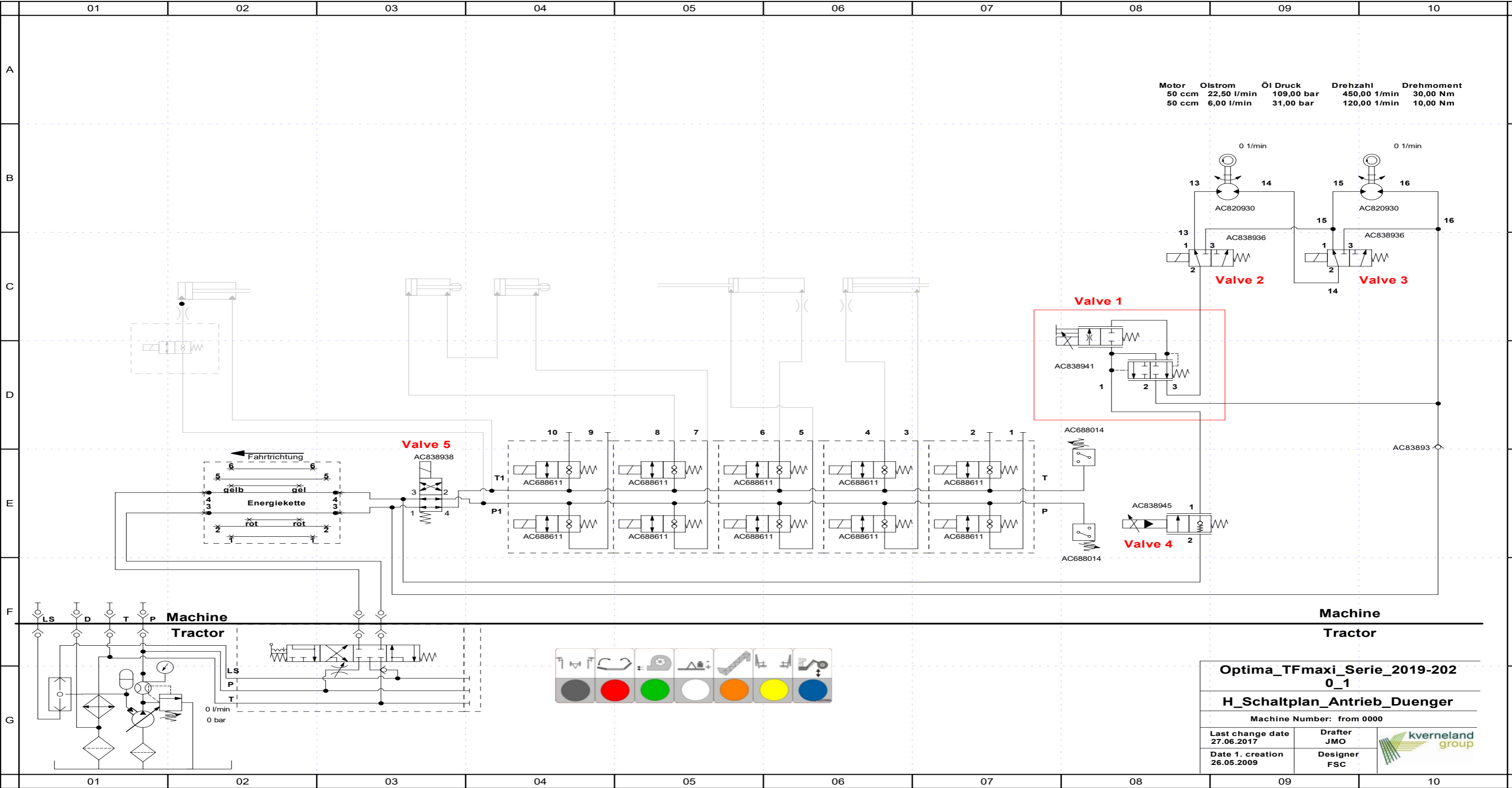

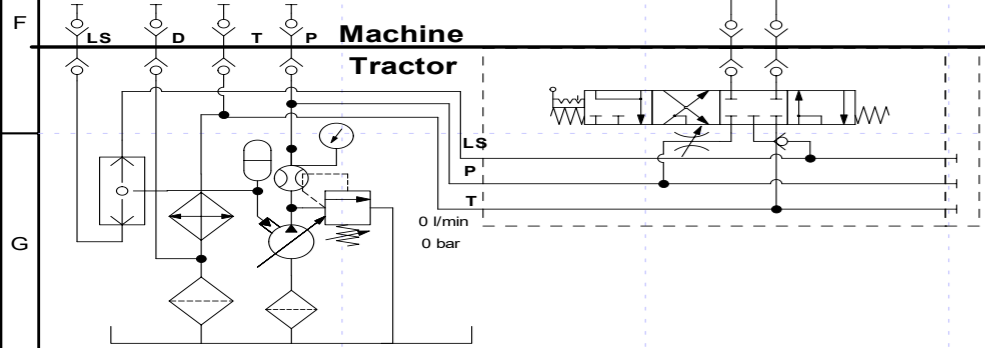

Motor	Olstrom	Öl Druck	Drehzahl	Drehmoment
50 ccm	22,50 l/min	109,00 bar	450,00 1/min	30,00 Nm
50 ccm	6,00 l/min	31,00 bar	120,00 1/min	10,00 Nm



Optima_TFmaxi_Serie_2019-202		
0_1		
H_Schaltplan_Antrieb_Duenger		
Machine Number: from 0000		
Last change date 27.06.2017	Drafter JMO	
Date 1. creation 26.05.2009	Designer FSC	

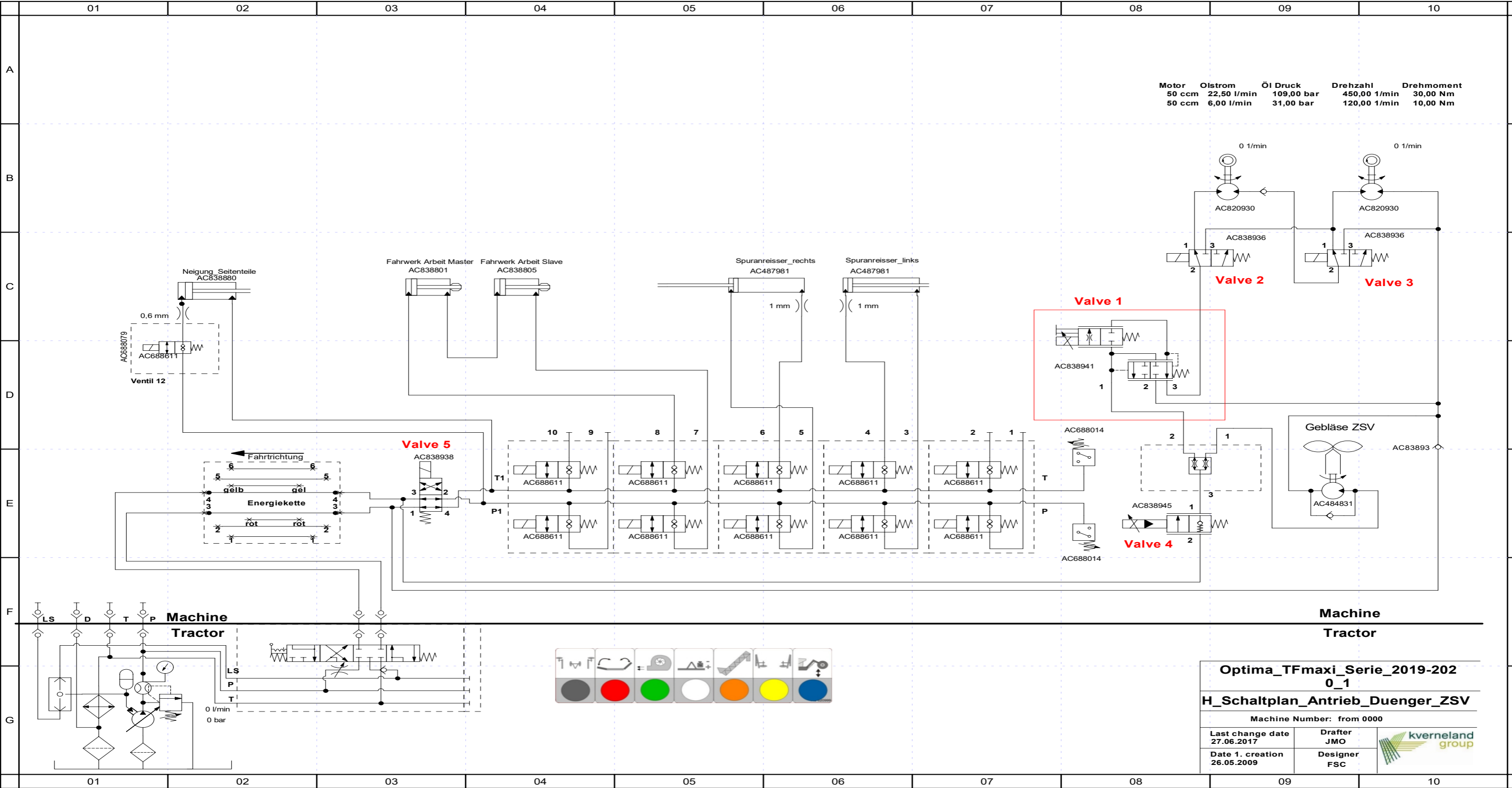

Motor	Olstrom	Öl Druck	Drehzahl	Drehmoment
50 ccm	22,50 l/min	109,00 bar	450,00 1/min	30,00 Nm
50 ccm	6,00 l/min	31,00 bar	120,00 1/min	10,00 Nm

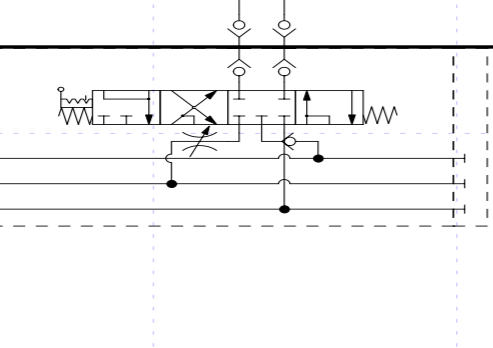
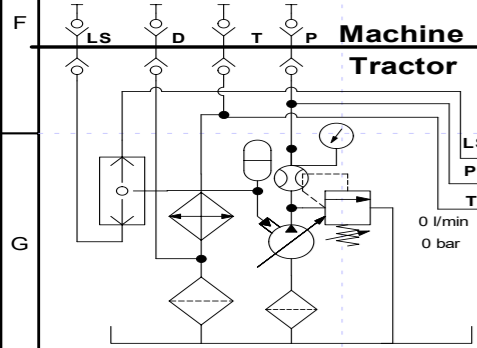

Optima_TFmaxi_Serie_2019-202	
0_1	
H_Schaltplan_Antrieb_Duenger_ZSV	
Machine Number: from 0000	
Last change date 27.06.2017	Drafter JMO
Date 1. creation 26.05.2009	Designer FSC



01

02

03

04

05

06

07

08

09

10

A

B

C

D

E

F

G

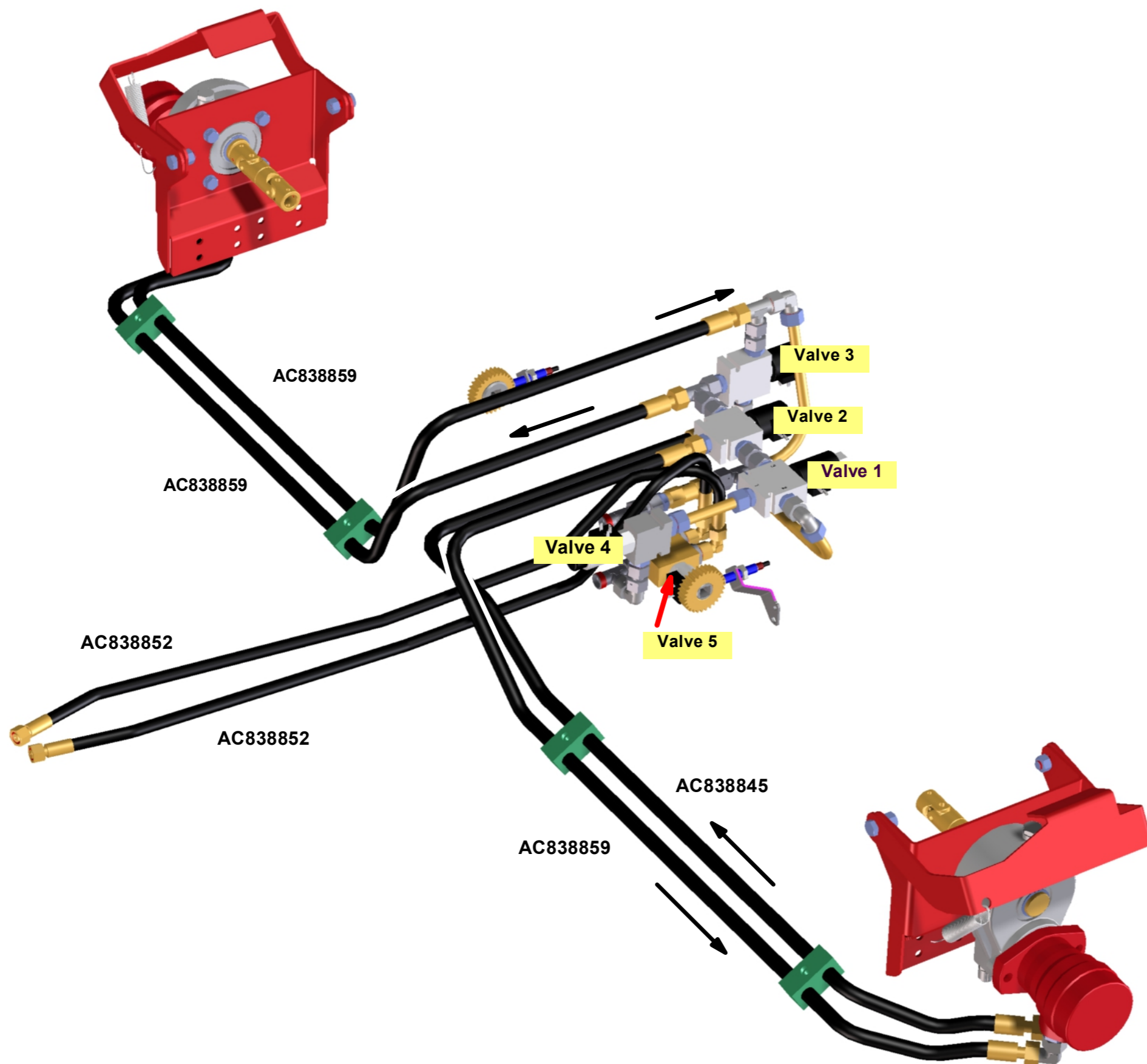

Machine
Tractor

Optima_TFmaxi_Serie_2019-202
0_1

Schlauchverlegung_Antrieb_Duenger

Last change date
27.06.2017

Drafter

Date 1. creation

Designer



01

02

03

04

05

06

07

08

09

10

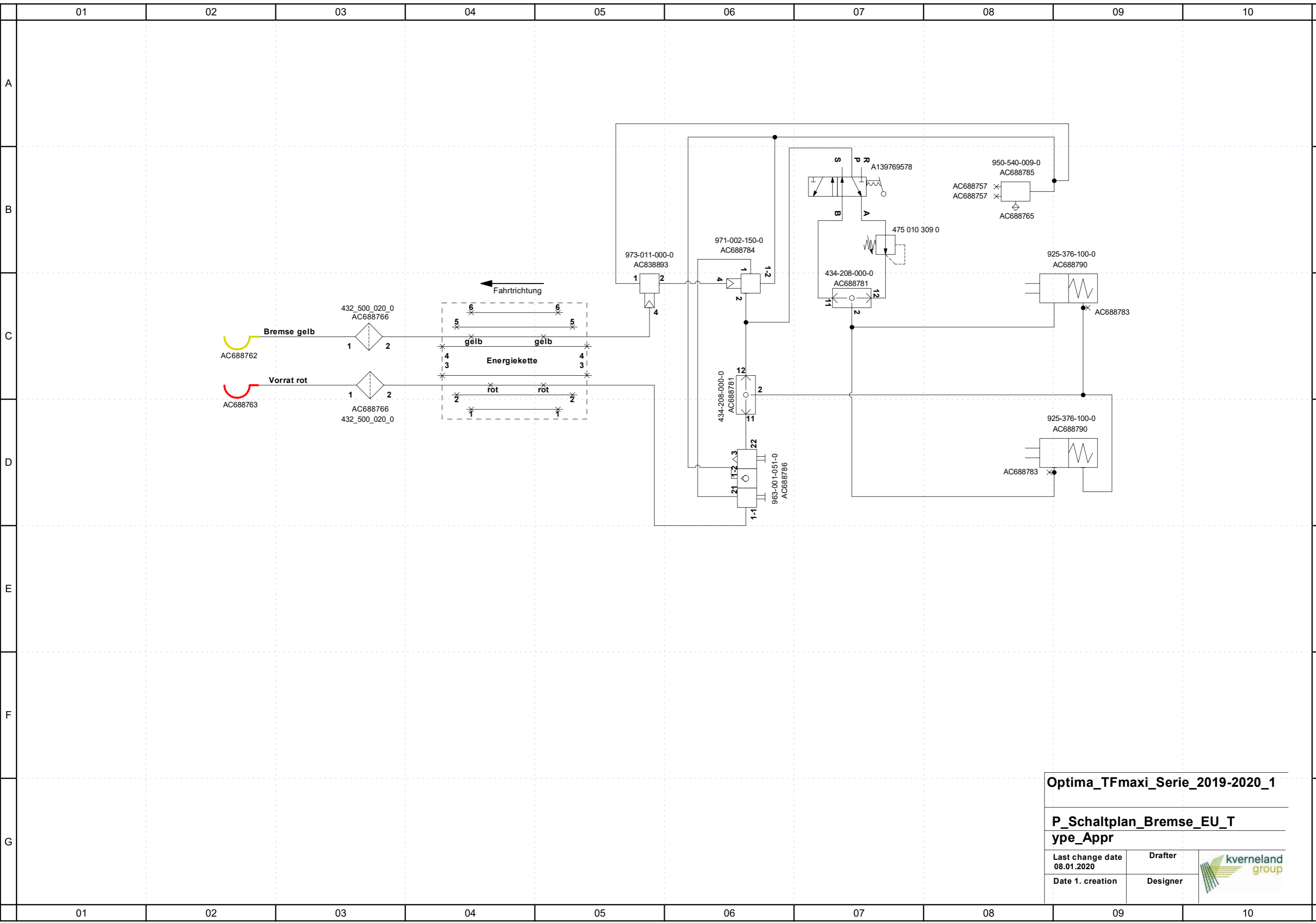

Optima_TFmaxi_Serie_2019-2020_1

P_Schaltplan_Bremse_EU_T
ype_Appr

Last change date
08.01.2020

Drafter
Designer



ESA TF MAXI

X FOLD

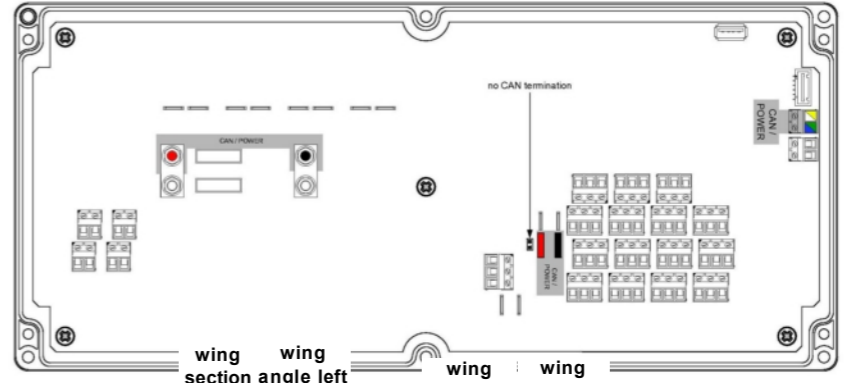
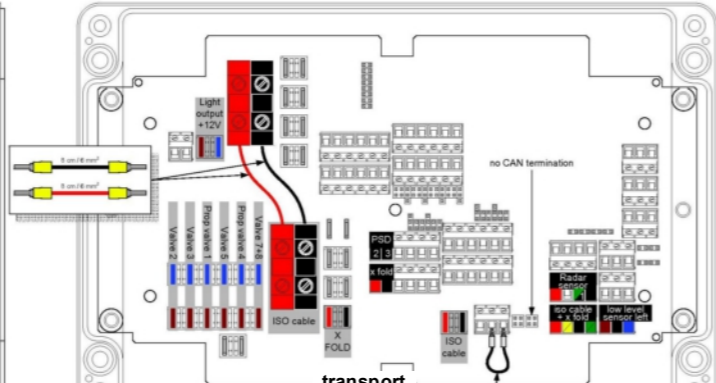
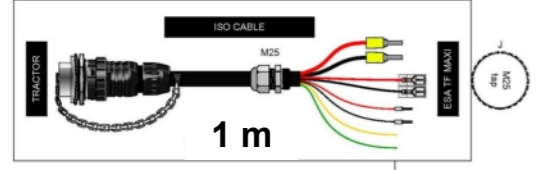

- A=Hydraulic valves
- B=Lights Lamp
- C=Signal Radar to PSD
- D=Power CAN to PSD
- E=Radar Sensor
- F=Start/Stop Sensor
- G=Sensor Big Wheels
- H=Low level sensor
- I=Motor encoder
- J=ISO cable
- K=CAN/Power X FOLD

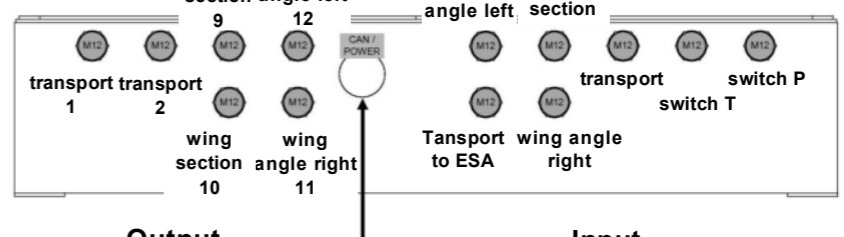
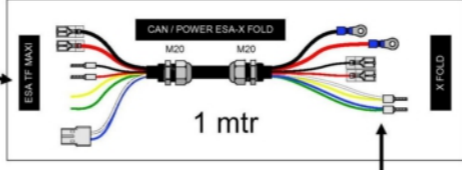
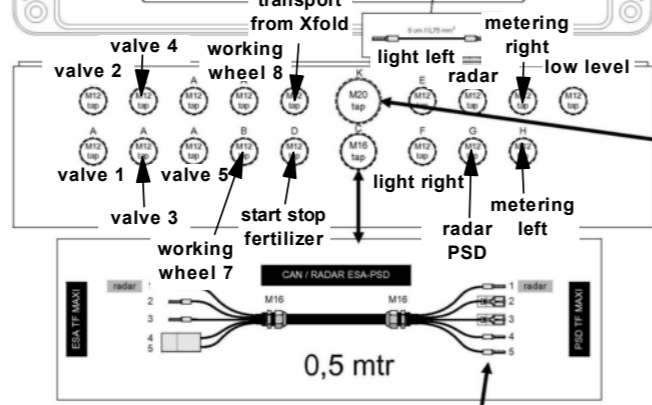

PSD TF MAXI

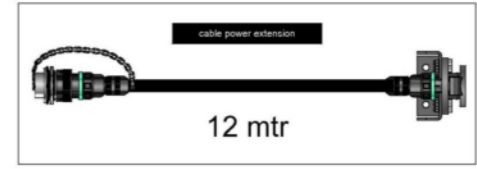
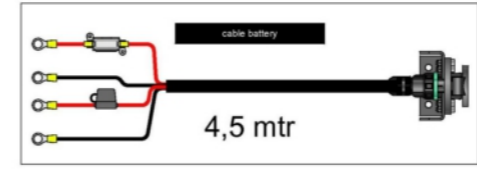
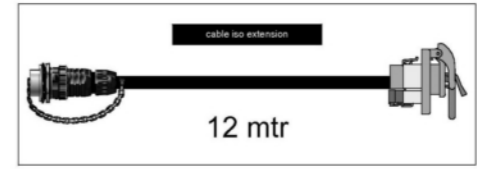
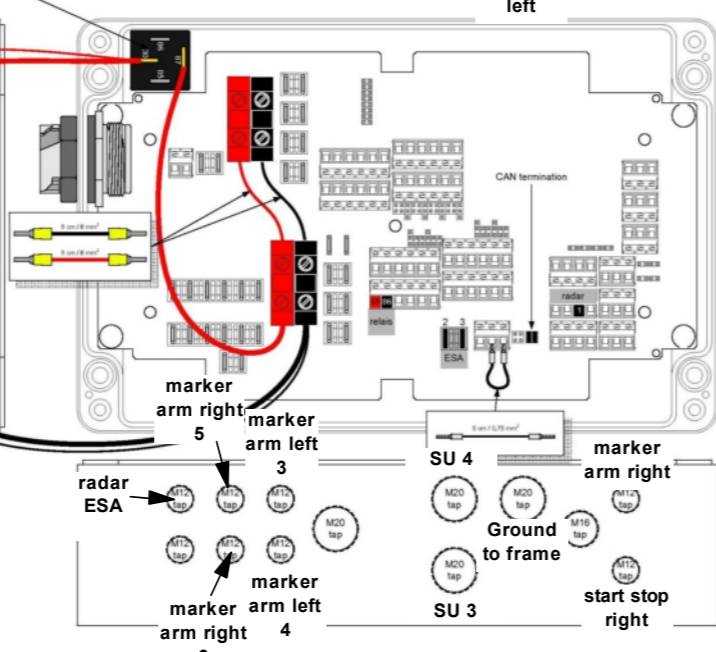
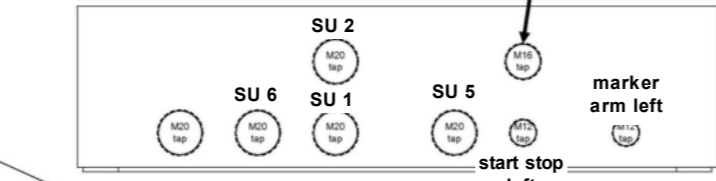
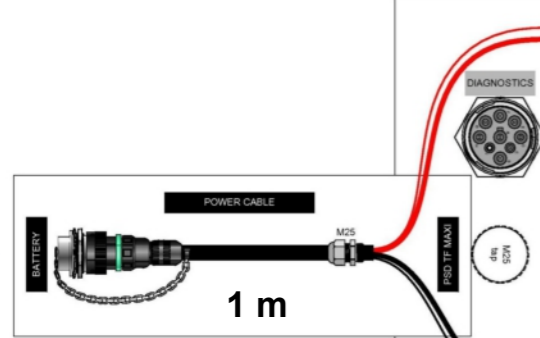

Optima_TFmaxi_Serie_2019-202
0_1
Main_Boxen_PSD_ESA_Xfold

Last change date
27.06.2017

Drafter
Designer



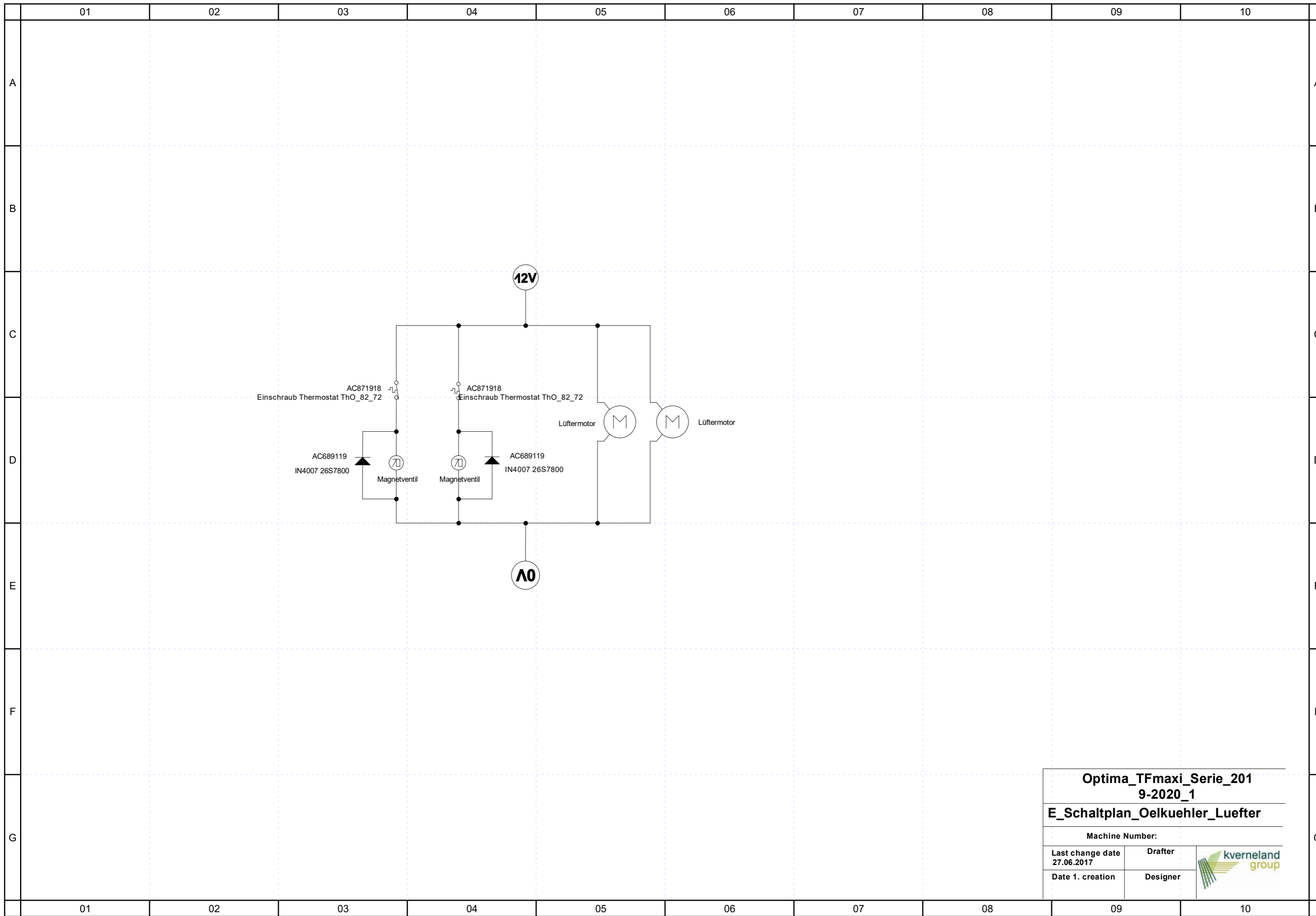

Optima_TFmaxi_Serie_201	
9-2020_1	
E_Schaltplan_Oelkuehler_Luefter	
Machine Number:	
Last change date 27.06.2017	Drafter
Date 1. creation	Designer



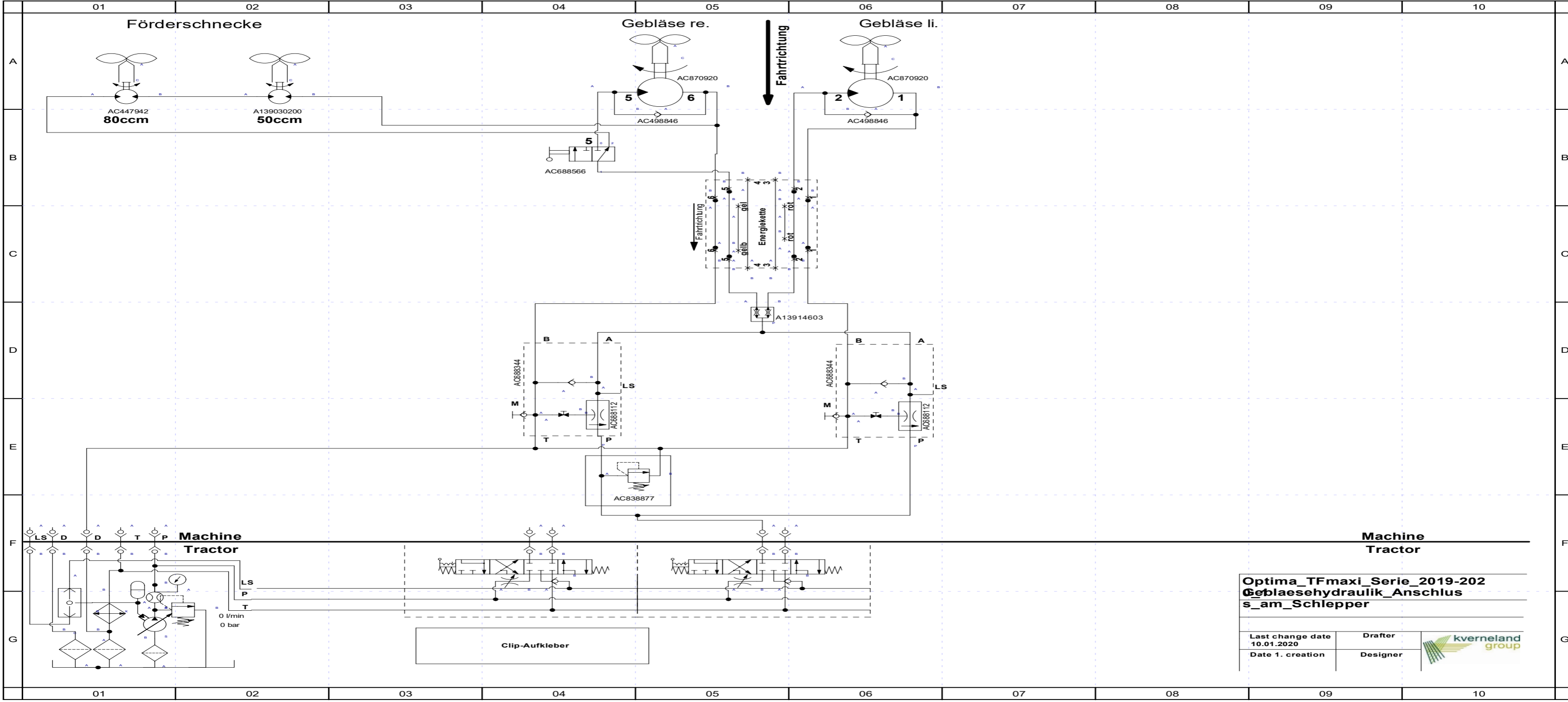

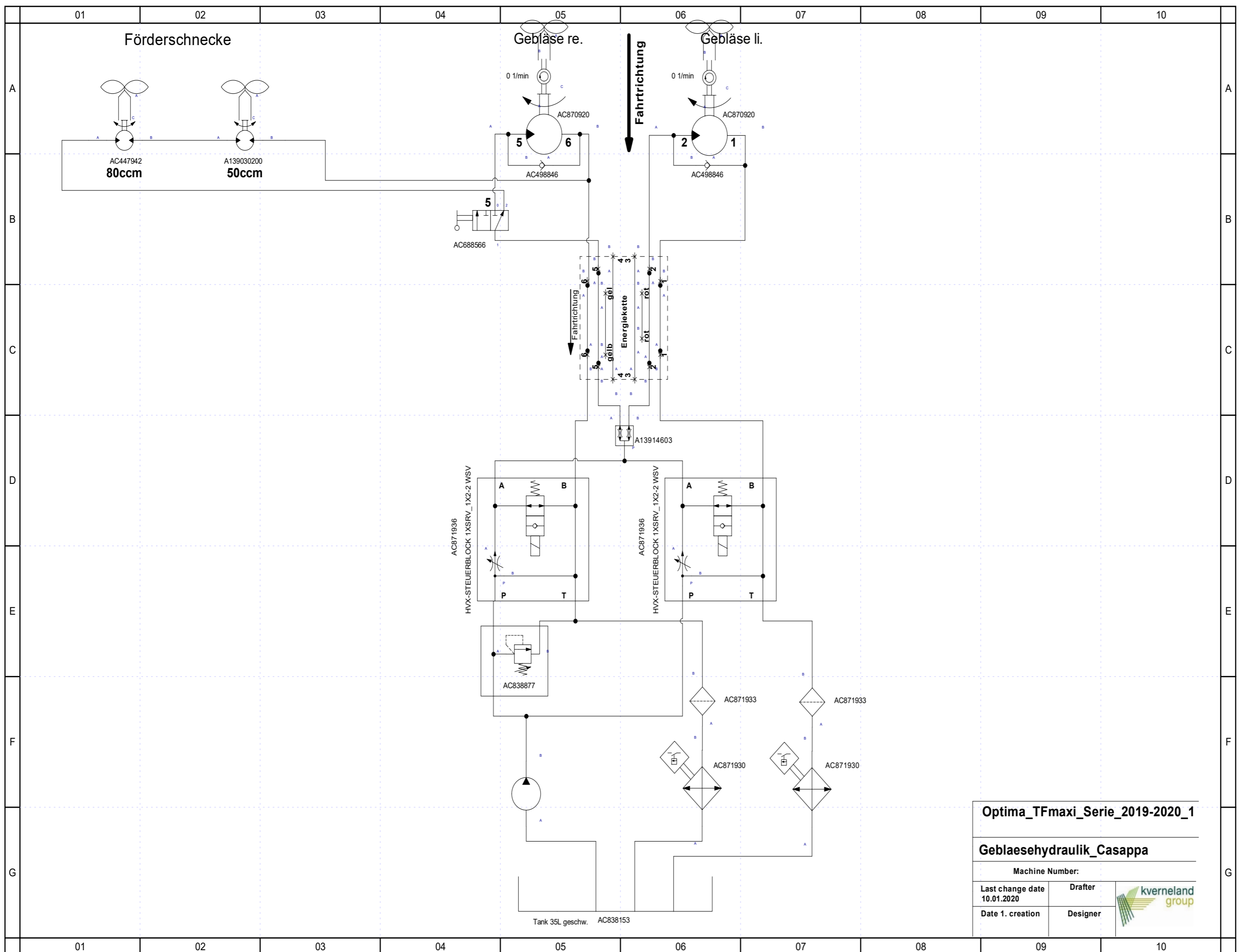

Optima_TFmaxi_Serie_2019-2020_1

Geblaesehydraulik_Casappa

Machine Number:

Last change date
10.01.2020

Drafter

Date 1. creation

Designer

