

INSTRUCTION MANUAL

ZEN  
ZEN 640



carrarospray®

**CARRAROSPRAY**



<b>DESCRIPTION</b>	<b>PAGE No.</b>
WELCOME	2
INTRODUCTION	3-4
MARKINGS AND IDENTIFICATION	5
DELIVERY OF THE MACHINE	6
DESCRIPTION OF THE COMPONENTS OF THE MACHINE	7
PROPELLER	8
HANDGUN	9
SIGNS AND WARNINGS	10-11-12-13
SAFETY RULES FOR THE OPERATOR	14-15-16-17
HITCH THE MACHINE TO THE TRACTOR	18
CORRECT USE OF THE DRIVE SHAFT	19-20-21-22
HOW OPERATING WITH A NEW MACHINE	23-24-25-26
INSTRUCTION OF USE OF THE SPRAYERS	27
CALIBRATION AND RATE CHART	28-29
PREPARING THE CHEMICALS	30
GENERAL MAINTENANCE	31
CLEANING AND MAINTENANCE OF THE MACHINE	32
FILTERS AND NOZZLES	33
USE OF THE PUMP	34
MAINTENANCE OF THE PUMP	35
DIAPHRAGM AND VALVE REPLACEMENT	36
LUBRIFICATION	37
ROAD CIRCULATION	38
TRANSPORT	39
TROUBLESHOOTING	40
WARRANTY TERMS	41

## **WELCOME**

Dear customer, we like to thank you for the purchase of this machine. We welcome you among our clients and are confident that this product will give you many years of reliable use and will fulfill your needs.

This "Use and Maintenance" manual applies to all versions of the 3 point mounted sprayers.

Remember that any machine can work well and profitably only if it is used correctly and kept in efficient working conditions. So please read this instructions manual carefully and check with it whenever difficulties arise.

Should you need any assistance, our technical department is at your disposal with information and service.

We remind you that, as manufacturer, we have the right to change, at any time, any part, detail or accessory of the machine, either in order to improve it or for marketing necessities. However, the changes made will not affect the main technical features of operation and safety.

The symbols given below are safety warnings and indicate that the instructions must be followed in order to avoid harms and/or damages to persons, animals and environment.

Failure to comply with the instructions may cause personal injury, in some cases even death.

Attached to this manual you will find also the operator's instructions of engine, pump, pressure regulator valve, drive shaft etc. made by other manufactures, as well as the breakdown and list of parts of the machine you purchased.

## ***INTRODUCTION***

This manual provides all the necessary information concerning the use and maintenance of the air blast, mist (low volume) and boom sprayers 3 point mounted on the tractor, as well as the list of spare parts.

The sprayers can be hitched to any tractor having 3 point hitch and an input shaft running at a maximum speed of 540 R.P.M. (revolution per minute).

The horsepower required to run the sprayer is connected to the type of pump which is mounted, to the size of propeller and the angle of the blades of the propeller (see chart reporting the data of your sprayer).

The sprayers are designed and manufactured for the use in open fields as well as for work between the rows of orchards, vineyards, etc..

Therefore **NEVER RUN THE SPRAYER INDOOR!**

Regular and adequate operation of the machine depends on correct use and maintenance.

The technical instructions that are contained in this manual must be therefore strictly complied with, to prevent any problem that could obstacle the correct use of the machine and reduce its life.

Compliance to the safety requirements mentioned herein is also essential to prevent accidents or injuries to the operator and other parties.

**ANY USER OF THIS MACHINE IS WARMLY REQUIRED TO READ CAREFULLY AND UNDERSTAND ALL THE INSTRUCTIONS OF THIS MANUAL BEFORE STARTING TO USE THE MACHINE.**

Should these instructions, or even one of them, not be complied with, then the Manufacturer can not be held liable for any damages whatsoever that are caused to the machine itself, to things or to persons.

This handbook is part of the machines and must be carefully keep on file as long as the machine is operative.

Please refer to the Manufacturer's Engineering Dept. should you need any technical details or any information on how to improve the machine operation and efficiency.

Any repair has to be carried out only by skilled technicians, either of a dealer authorized by the manufacturer, or by the distributor.

For the repairs, only original spare parts can be used. Failing this the manufacturer shall not be held liable for incorrect operation of the machine and nor the user will then be entitled to any guarantee.

Should any doubt arise on the meaning of any part of this manual, the Italian texts shall be considered as the valid reference text.

## MARKINGS AND IDENTIFICATION

On the machine the user will find the following plates or decals:

1. Marking plate containing the name of the Manufacturer, the year of construction, the model, and the serial number.



2. Decals with general maintenance and lubrication instructions.
3. Decals indicating of how to use the machine.
4. Danger, warning and marking signals.

**Plates, decals and signs on the machine are parts of the machine itself and cannot be removed.**

The operator must comply with the instructions affixed on the machine and keep them in clean and legible condition as long as the machines is operative.



## ***DELIVERY OF THE MACHINE***

The machine must be checked immediately upon delivery to ensure that it is complete with all its components; should not be the case, the manufacturer and/or its representative must be notified at once.

The sprayer is supplied either wrapped with nylon or packed in a carton and all the components are appropriately protected for shipment. In order to save space and reducing risks of damages during transportation, some parts are supplied loose and need to be reassembled before using the machine. You need to follow these instructions:

- mount the pressure regulator on it's support
- mount the delivery and bypass hoses
- check that all the hoses are tight
- connect the hoses of the nozzles and of the handgun (if supplied)

**Run the sprayer, for the first time, *with fresh water*, to check that everything operates properly.**

## ***DESCRIPTION OF THE COMPONENTS OF THE MACHINE***

### **PUMP**

The diaphragm pump puts the liquid under pressure and is the hearth of the sprayer – it needs therefore a particular attention.

PLEASE READ CAREFULLY THE MANUAL PROVIDED WITH THE PUMP THAT IS FURNISHED ALONG WITH THIS MANUAL.

### **TANK**

The tank of the sprayer can be made either of fiberglass or polyethylene. Inside the tank there is an agitation system studied in order to keep the chemical uniformly and constantly mixed with the water, this during the spraying operations. The agitation system can be either mechanical or jet (sometimes both together).

It is important to have the agitation system in good working conditions at all the times, not only for the best job with the crops, but also because some chemicals could be dangerous if not mixed properly.

Before using any chemical, please read and apply carefully the directions printed on each container.

### **DRAINAGE OF THE LIQUID OF THE TANK**

It is very important to learn how and where to drain the residue liquid of the tank. All the tanks are provided with a drain valve with a lever. Even if the valve is designed in a way that the liquid would not touch the hands or clothes of the operator, this has always to be opened with care.

To avoid pollution, never drain the residue chemicals on the ground, but use instead appropriate reservoirs or drain ducts.

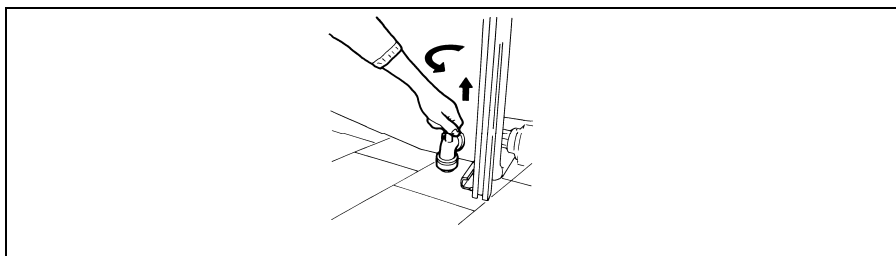



## PROPELLER

BEFORE PERFORMING ANY MAINTENANCE ON THE PROPELLER, BE SURE THAT THE MOTOR OF THE TRACTOR IS OFF AND THE TRANSMISSION OF THE PROPELLER TO BE DISCONNECTED. NEVER REMOVE THE SHIELDS OF THE PROPELLER WHEN THE TRACTOR IS RUNNING AND THE PTO CAN BE ENGAGED.

The purpose of the propeller is to produce the volume of air necessary to atomize the droplets of liquid sprayed by the nozzles. The result is a sort of fog that penetrates the foliage of the plants and makes the requested treatments.

The blades can be mounted with a different angle. Wider is the angle, more is the volume of air produced but, on other hand, there will be more absorption of power from the tractor.

In order to change the angle of the blades (ref. 2) of the propeller (ref. 3) you need special inserts (ref. 1) that you can receive from the manufacturer or the dealer.

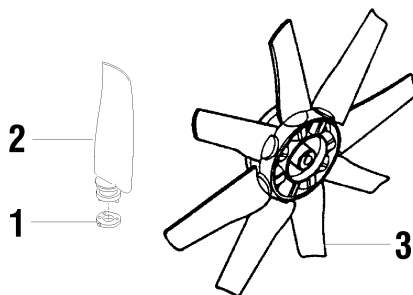

NEVER USE, ON THE SAME PROPELLER, INSERTS HAVING A DIFFERENT ANGLE, AS THIS COULD CAUSE SEVERE DAMAGES TO THE MACHINE.

Once replaced the inserts, MOUNT ALL THE SHIELDS ON THE ORIGINAL POSITION, THIS BEFORE RUNNING THE MOTOR.

## **HANDGUN**

The machine can be provided with a handgun (various models are available). The nozzles of the handguns can have different shape, diameter of the hole, according to the job that needs to be done.

The chart provided herewith shows different tips according to the pressure used.

The tips and the nozzles, either the ones of ceramic as well the ones of steel, wear out and need to be replaced. Do it when you notice that the delivery has increased or the spray pattern is not uniform.

**SIGNS AND WARNINGS**



Please carefully read and understand the operating instruction of the manual before using the machine.

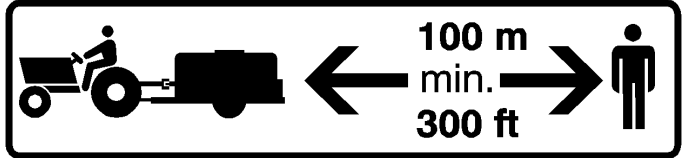

**DANGER:** the machine blows possibly dangerous chemical.  
Keep at a safe distance from the machine.



**DANGER:** never get close to the drive shaft when it is rotating.  
**GETTING IN CONTACT WITH THE DRIVE SHAFT COULD CAUSE YOUR DEATH!**

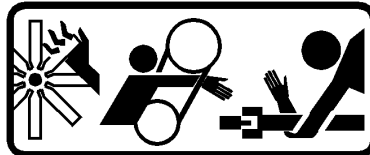

**DANGER:** keep hands, feet and clothes away from the moving parts.

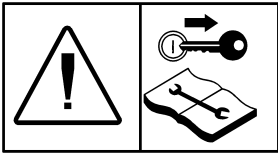

Before performing any service, stop both the machine and the tractor, verify that both are firm on the ground in a stable position and read the instructions of this manual in the section referred to the service.



**Only qualified personnel must use the machine.  
Keep the machine away from children also when it is off.**

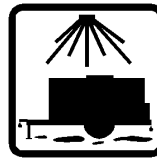

Wash the machine with plenty of water after each working phase. Do not drop the chemicals in the environment.



If the chemical product gets in contact with eyes, hands, skin or clothes, neutralize them with suitable products and rinse with plenty of water.



Keep clear of the machine when it is in operation.



Hitching point for lifting the machine.

Make sure that the capacity of the vehicle used for transport is sufficient to lift the maximum weight of the machine.

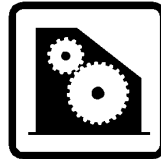

Never remove safety shields when the machine is running. All the shields must stay in place during all the life of the machine.



Get a thorough knowledge of the chemical products used and learn how it must be neutralized in case of contact with skin or eyes.



Never run the PTO (Power Take Off) at a speed exceeding 540 R.P.M. (Revolutions per Minute).

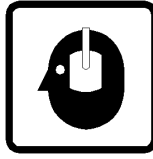

Use special goggles, boots, overall working clothes, gloves, dust proof mask or certified helmets with filter when you use the sprayers.



Use only drive shafts with certified safety shields.



Carry out all the maintenance operations before starting to use the machine.



Avoid sharp angles of drive shaft because this could damage the joints, the pump and the PTO of the tractor.  
Stop the PTO of the tractor when taking a turn.



## ***SAFETY RULES FOR THE OPERATOR***

**Before using the machine, please carefully read the safety rules and the recommendations of how to prevent accidents that are described in this manual.**

These rules must be strictly complied with to ensure safety of the operators and other people as well as the environment.

The Manufacturer and its Sales network will not be considered liable in the case that such rules are not complied with.

The sprayers are machines designed and built for the use of chemical products, which could be very dangerous if handled, or just touched, by persons with no adequate skill.

- It is forbidden to allow the use of the machine to people less than eighteen years of age or to people without adequate skill.
- Never run the machine indoors, because the air could be poisoned not only by the chemicals, but also by the fumes of the motor.
- Do not transport the machine with tank full of chemical.
- Do not allow anybody other than the operator in a radius of less than 100 meters (300 ft) when the sprayer is working.
- Check frequently the tightness of fittings and hoses. If it is the case fix or replace.
- Never remove any shield or guard and, if some is damaged, repair it promptly without running the machine while waiting for the replacement.
- Always wear suitable protective clothing, especially during preparation of the product, treatment, when cleaning the nozzles and filters, emptying the tank and washing the machine.
- Avoid inhaling the gases inside tanks.
- **During treatments it is advisable to use overall working clothes, goggles, gloves, dust proof must or helmets and boots resistant to the chemicals.**
- **The sprayers are designed to broadcast chemicals in agriculture; the constant use of chemicals makes of the**

**machine a potentially dangerous implement, of which everybody must be aware.**

- Before using the chemicals, read and understand all the warnings and directions given by the manufacturer of the chemical and: **LEARN OF HOW TO ACT IF ACCIDENTALLY THE CHEMICAL WOULD BE TOUCHED BY SOMEONE OR WOULD BE SPREAD IN THE ENVIRONMENT.**



**BEWARE: the sprayers are machines where some parts are rotating at a very high speed, which, even if protected, are still potentially dangerous.**

- 1) Pay careful attention to warning, danger and marking signals that are both contained in this handbook and affixed to the machine.
- 2) Any time the machine need to be serviced, the motor of the tractor must be off, the gear engaged, the hand brake pulled and the machine must be firmly parked on the ground.
- 3) Never touch parts while they are in motion. **This could cause your death.**



**When in operation, the sprayer blows chemical products. Therefore, always make sure that no persons or animals are within the reach of the machine. When making this evaluation, consider also possible wind.**

**Minimum distance between persons and working place: 100 Mt. (300 ft). Never work when persons are in areas at risk.**

The machine must be used by one person only who must operate it from the tractor's driver seat. Nobody else is necessary, therefore no other

persons must approach the dangerous area. Minimum distance from the machine while in operation: 100 Mt. (300 ft.).

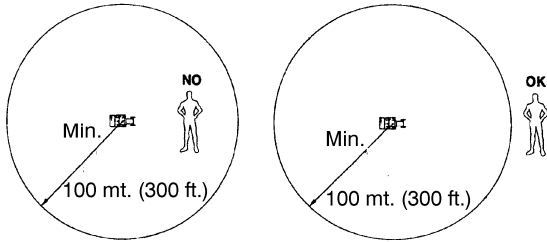

Should someone come too close to the machine, then immediately stop any operation you are carrying out and warn these persons with acoustic and light signals until they leave the dangerous area, where they could be contaminated by chemicals, overrun by the tractor or be injured by machine mechanisms. Risks due to parts that are in motion and from sudden change of the wind's direction could be unavoidable.



**Warning: It is strictly forbidden to stay between the tractor and the machine when the engine is on. This can cause your death.**

Never wear clothes with free ends (such as belts, scarves, heads-squares, long skirts, etc.) that could drag you towards the machine parts while they are in motion.

The operator should keep all shields, of which the machine is equipped, in steady and sound conditions. After any service or repair, **all the shields must be put in the original place.**

**Before stopping and/or starting the engine of the tractor be sure of:**

- **The PTO must be disconnected**
- **The attached implement is firm on horizontal ground**
- **The hand brake is pulled**

The recommended position to use the lifting system of the tractors is **only** from the tractor's seat.

When replacing any worn out pieces or during any other operation on the machine (which must be carried out by skilled technicians) please proceed as follows:

- make sure the engine is stopped, hand brake pulled and PTO disengaged
- in case of the need of servicing the machine from underneath, make sure that this would rest safely on proper supports, in order to prevent any accidental fall which would seriously injure someone.
- every intervention must be carried out on a clean horizontal floor.



Should the machine accidentally bump into an obstacle, then proceed as follows:

- stop immediately the machine and following all the above-mentioned safety instructions.
- check the machine carefully, to be sure there are no damages.
- In the case of doubts please check with the service department of an authorized dealer.



- **From tests made with the sprayers it resulted that the noise level close to the machine can reach 92 decibel. This means that the operator has to use appropriate noise canceling headset.**
- **Never put in the tank any flammable or explosive liquid such gas or diesel fuel, oil or other hydrocarbons.**



## **HITCH THE MACHINE TO THE TRACTOR**

**The attachment of the machine to the tractor is a dangerous operation.** It is recommended that such operation be carried out strictly complying with the following instructions and paying careful attention.

- **BEWARE:** In order to attach or set the machine, any operations must be carried out with the machine laid flat, tractor on standstill, engine off, pulled parking brake and low gear inserted. Only the machine operator and the technical staff authorized by the Dealer can be there.
- When working on the machine make sure nobody else is coming too close.
- Make sure the tractor power is appropriate for the machine is going to be attached.
- Never use tractors whose power exceeds that foreseen for the machine, as this has been tested with such power, exceeding which all machine members could suffer serious damages that are not covered by the guarantee.
- Make sure that the pull capacity of the tractor, as well as its weight, are sufficient to lift the machine when this is fully loaded of liquid and ready to work. **For these important safety instructions please refer to the owner's manual of the tractor.**
- Consider that the 3 pt. sprayer, when it is full of liquid, could put out of balance the tractor which may then need front weights.
- Particular care has to be taken also when driving it down hill as well if it is necessary to take a sharp turn. In these cases the speed of the tractor has to be the lowest possible.
- Make sure that the tractor's lifting arms are provided with articulated balls having a hole of the same diameter of the pins of the sprayer. Make also sure also that the pins are provided with a locking system to prevent possible disconnection of the machine from the tractor while it is operated or driven.



## ***CORRECT USE OF THE DRIVE SHAFT***

Check the working angles of the drive shaft making sure, in working position, that both input shafts of the tractor and of the machine are parallel.

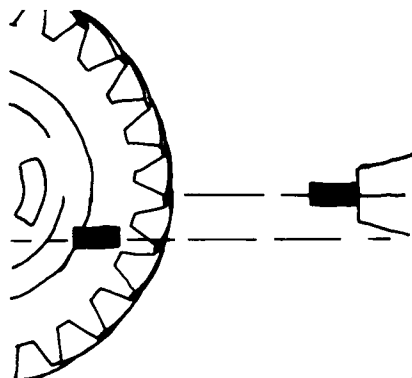

Make sure that the drive shaft's angles do not exceed  $10^\circ$  in working position bearing in mind that wider is the angle, shorter is the life of the shaft.



## ***DRIVE SHAFT***

1. It is always very important to determine the right length of the drive shaft for a good performance as well as for avoiding damages.
2. Check that the input shaft of the tractor would have the same size, type and number of splines as the yoke of the drive shaft on the tractor side.

3. Check if the RPM of the tractor's PTO are the same foreseen for the machine to be attached (normally 540 RPM).
4. Check if the tractor's PTO rotates clockwise (please look at it from behind).



5. Use only the drive shaft supplied or recommended by the Manufacturer.
6. When mounting the drive shaft to the input shaft of the machine pay attention if there is any mark showing the tractor side and machine side (for example any limiting device has to be mounted on the side of the machine).
7. Lay the drive shaft to the appropriate holding hook to prevent that the sliding half would drop to the floor.

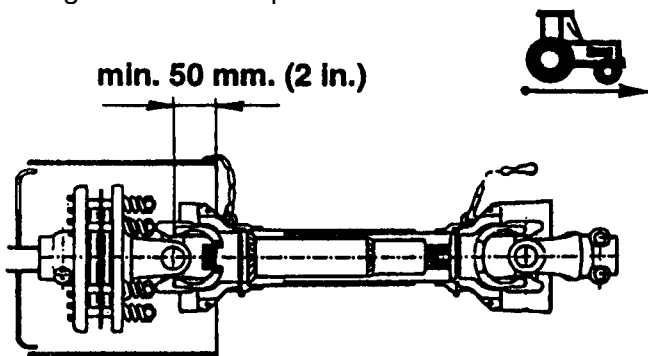

8. Drive the tractor on reverse until the lifting arms are close to the pins of the of the sprayer and the hitch of the tractor do match.
9. Switch the motor off, pull the hand brake and leave a low gear engaged.
10. Connect the drive shaft to the input shaft of the tractor, double-checking again that a minimum distance of 5 to 10 cm (2 to 4 in.) is allowed to the completely closed position of the drive shaft.

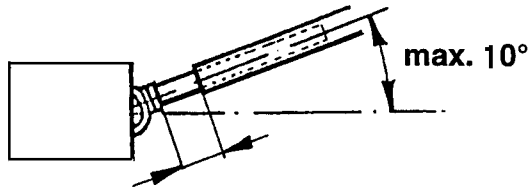

**MIN. 5 cm. (2 inch)**

11. In its longest position the two halves of the telescoping tubes of the shaft must overlap of at least 1/3 of their length. In the case that the drive shaft would result too short, get from an authorized dealer a new one of the same type approved by the manufacturer.

**1/3 OVERLAP**

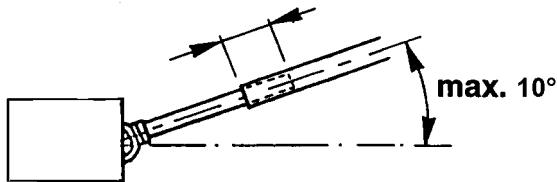

12. Should it be necessary to change the length of the drive shaft, it is essential, for safety reasons that the operation is carried out by skilled technicians. Safety devices must comply with the new length.
13. Proper equipment must be used to keep rotating parts coaxial and yokes in their original angle position.
14. FOR OTHER IMPORTANT INFORMATION REFERRED TO THE DRIVE SHAFT, PLEASE SEE ALSO THE MANUAL SUPPLIED WITH IT BY THE SHAFT'S MANUFACTURER.
15. **BEWARE: incorrect use of the drive shaft may cause damages to it. Such damages are excluded from warranty, event though they are caused within the warranty period. The misuse and/or abuse to the drive shaft can cause damages to the tractor, to the machine or injuries to people.**

16. Insert the articulated balls of the arms of the tractor into the pins of the sprayer and then insert the lock pin.
17. Connect the top link taking attention to adjust it in a manner that the PTO of the tractor and the one of the machine are parallel each other and horizontal with the ground. It is very important that input shafts would be parallel for a longer life of the drive shaft.
18. Link to the machine the chain that is attached to the guard, which prevents it from rotating.

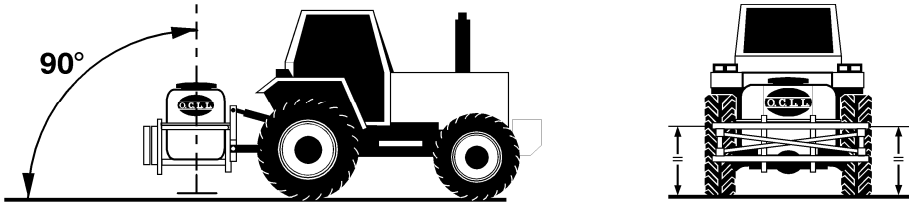

19. Tighten the chains in order to avoid side swinging.

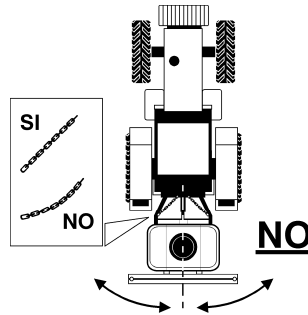

20. Be sure that at least 20% of the total weight of the tractor plus sprayer is on the front axle. In negative case put front weight in order to make the convoy more stable.



## **HOW OPERATING WITH A NEW MACHINE**

1. Inspect for loose or missing parts and possible damages.
2. Make sure all fittings and drive components are secure.
3. Lubricate the parts that need to. See Lubrication Section for details.
4. Check tank for any foreign objects.
5. Fill tank 1/2 full with clean water. DO NOT add and spray chemicals until the sprayer is started, adjusted and calibrated.

### **PREPARE THE SPRAYER**

THE SPRAYER IS A MACHINE THAT CAN BE OPERATED ONLY BY SKILLED PEOPLE AS IS POTENTIALLY DANGEROUS BOTH FOR THE OPERATOR AND FOR THE ENVIRONMENT IN THE CASE SOME SPECIFIC RULES WOULD NOT BE RESPECTED.

#### **1. CHECK AND CLEAN THE FILTER**

Close the valve (1) that is placed between the tank and the filter, unscrew the lock ring of the filter (3) and clean the cartridge (4). In the case the cartridge would be damaged or worn out, replace it with one of exactly the same type.

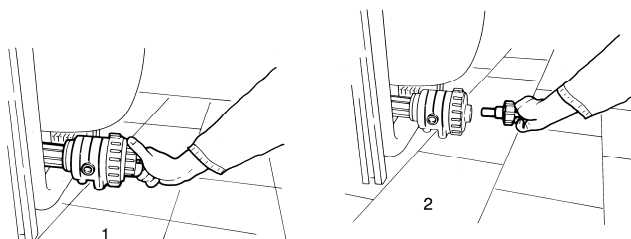

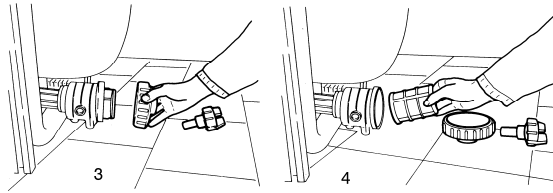

After having replaced the cartridge and the cap in its position, it is possible to open the valve of the filter to allow the suction from the tank.



## 2. SPEED OF THE PROPELLER

The sprayer is provided with a shift lever that permits to engage and disengage the propeller.

Before operating on the lever, be sure that the tractor is off and the PTO is disengaged.

Position 1: the propeller is in neutral and it is possible to use the handgun.

Position 2: the propeller is rotating and produces air.

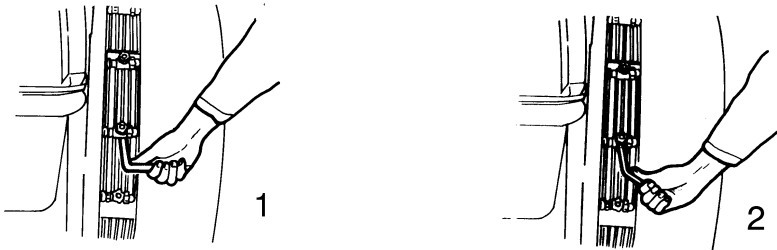

## 3. AGITATOR

Before starting to spray it is important that the agitator (either mechanic or hydraulic) would operate for some minutes in order to have a uniform mix in the tank.



#### **4. ADJUST THE WORKING PRESSURE**

To adjust the pressure of the pump look at the gauge mounted on the regulator of the sprayer.

Choose the pressure following the charts provided with the chemical and according to the quantity of product you plan to spray.

It is important that every adjustment of the pressure would be made by turning the valve very slowly. In fact too quick changes of pressure could damage the components of the machine such pump, valves, hoses etc.

During the work it may be necessary to re-adjust the pressure as some tractors may not maintain the same power at all times.

Note: the pressure varies according to the tips mounted on the nozzles.

The regulator valve is designed to adjust the pressure of the spray and to allow the excess of liquid to return into the tank.

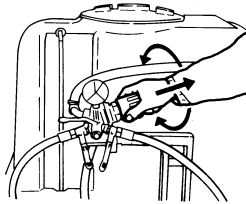

Note: The manual provided by the manufacturer of the pump provides also information of how to operate the regulator valve. Note also that the main valve may change on design.



#### **5. USE OF THE NOZZLES AND OF THE MANIFOLDS**

The nozzles are mounted on the LH and RH manifold. Acting on two levers mounted on the regulator can operate them separately. The use of

one only manifold may be necessary when one side only needs to be treated, for example for the external rows.

## 6. USE OF THE HAND GUN

In order to use the handgun it is necessary to disengage the propeller and to connect the hose of the gun on the fitting that is on the pressure regulator. Should you not have connectors available on the regulator, you may use the one of which the pump is normally provided or you may disconnect one of the manifold.

Before connecting the handgun se sure that the fittings, the hose and the gun are designed for the maximum pressure supplied by the pump.

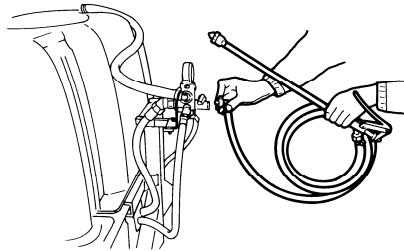

Check periodically the handgun, the hose and the connectors and replace immediately the parts that are defective (cracks, leaks etc.). This is very important for the safety of the operator and the environment.

It is absolutely forbidden to use hoses fixed with straps as they could easily blow out. Use only hoses with self-locking or threaded connectors. The lack of respecting these rules could cause severe damages and/or injuries.

Before starting any work, it is advisable to test the unit with clean water, in order to get used to it and to the handgun and for making the fine-tuning.



## **INSTRUCTION OF USE OF THE SPRAYER**

1. Position the regulator valve in by-pass position and close all the levers (manifold, handgun and/or other accessories).
2. Be sure that the machine is horizontal
3. If the chemical mix has not been already prepared in advance, fill the tank with some clear water and then introduce the chemical. Then fill the rest of the tank with clear water up to approximately 3 cm (1 ¼ in.) to the bottom of the strainer basket.
4. Start the tractor being sure that the hand brake is pulled and PTO disengaged.
5. Engage slowly the PTO
6. Increase the speed of the motor until you reach 540 R.P.M. at the PTO.
7. Set the lever of the regulator valve on work position and check on the gauge that the pressure would not be too high.
8. Open the lever of the nozzles or of the handgun and adjust gradually the pressure until you reach the one you desire.
9. To stop the treatment first set the lever on by-pass position and then close the levers of the nozzles.

TEST: It is advisable, before proceeding to the first treatment, to test the machine with clear water in order to check:

- If everything works properly on the machine
- If the adjustments liter/hectare or gallon/acre are correct
- To get used to the machine



# CALIBRATION AND RATE CHART



## FORMULA AND RATE CHART FOR CALIBRATING

The following data must be known: {

- 1) Tree spacing (swath width) in metres (m).
- 2) Tractor speed in (Km/h).
- 3) Litres per hectare desired (Lt/h).

Note: 1 hectare = 10.000 m<sup>2</sup>

[Tree spacing \_ (m)] x [Speed \_ (km/h) x Litres per hectare desired \_ (Lt/ha)]: 600 = \_ (Lt/min).

Next: \_ Lt/min. \_ nr. of tips = \_ Lt/min each tips.

Now choose the appropriate tip and pressure setting.

### •Delivery chart for single tip (Lt per minute) [Lt/min]

	TIP Ø	SWIRL PLATE Ø	BAR	10	15	20	30	40
			PSI	150	220	300	450	600
<b>540</b> R.P.M.	0.8	0.0	Lt/min.	0.98	1.21	1.40	1.72	1.98
	1.0	0.0	Lt/min.	1.43	1.73	1.98	2.41	2.80
	1.2	0.0	Lt/min.	1.53	1.87	2.14	2.57	2.95
	1.2	1.0	Lt/min.	2.31	2.75	3.14	3.78	4.29
	1.5	1.2	Lt/min.	3.58	4.38	5.05	6.20	7.13
	1.8	1.5	Lt/min.	5.31	6.50	7.50	9.20	10.60
	2.0	1.8	Lt/min.	6.65	8.15	9.40	11.50	13.30

**Note:** any difference between values measured in the field and the values indicated in the tables may be due to various factors: viscosity of the chemical products used, differences in the tractor speed, filter not perfectly clean. It is advisable to verify capacity and consumption with clean water before the treatment. The above values are for reference only.

**SPRAY GUN'S DELIVERY LT/MIN**

<b>CONE TIPS IN STAINLESS STEEL</b>	<b>PRESSURE WORKING BAR</b>										
---	---------------------------------	--	--	--	--	--	--	--	--	--	--

REF.	DIA.	5	8	10	12	15	18	20	25	30	40
0800176	1.0	1,1	1,3	1,5	1,7	1,9	2,1	2,3	2,5	2,8	3,3
0800177	1.2	1,5	1,7	2,0	2,3	2,7	3,0	3,2	3,6	3,9	4,8
0800179	1.5	2,4	2,9	3,3	3,8	4,3	4,8	5,1	5,6	6,2	7,5
0800180	1.8	4,0	4,6	5,1	5,6	6,3	6,9	7,2	8,2	8,9	10,8
0800181	2.0	5,0	5,6	6,3	6,9	7,7	8,5	8,8	10,0	11,0	13,4

**SPRAY GUN'S DELIVERY LT/MIN**

<b>CONE TIPS IN CERAMIC</b>	<b>PRESSURE WORKING BAR</b>										
---------------------------------	---------------------------------	--	--	--	--	--	--	--	--	--	--

REF.	DIA.	5	8	10	12	15	18	20	25	30	40
0800262	1.0	1,1	1,3	1,5	1,7	1,9	2,1	2,3	2,5	2,8	3,3
0800263	1.2	1,5	1,7	2,0	2,3	2,7	3,0	3,2	3,6	3,9	4,8
0800264	1.5	2,4	2,9	3,3	3,8	4,3	4,8	5,1	5,6	6,2	7,5
0800265	1.8	4,0	4,6	5,1	5,6	6,3	6,9	7,2	8,2	8,9	10,8
0800266	2.0	5,0	5,6	6,3	6,9	7,7	8,5	8,8	10,0	11,0	13,4
0800267	2.2	6,1	6,8	7,7	8,4	9,4	10,3	10,8	12,1	13,3	16,2
0800268	2.5	8,2	8,8	9,9	10,8	12,1	13,3	14,0	15,7	17,2	20,8
0800269	3.0	10,5	12,7	14,2	15,6	17,5	19,1	20,1	22,5	24,8	30,0

The tips of the spray gun, made either in ceramic or stainless steel, may wear out and need to be replaced. You have to do this when you note that the delivery has increased or the spray work is not uniform.



## PREPARING THE CHEMICALS

**WARNING:** keep the products in ventilated premises with a door fitted with a lock inaccessible both to children and to unauthorized persons. Place warning notices on the outside indicating the danger zone.

Before preparing the mixture to be sprayed:

1. Calculate the exact amount of the chemical product needed for the area to be treated, so as to be able to prepare the exact quantity of product to be sprayed. The chemical product must be kept in their original package, supplied with their own labels.
2. Ensure that the machine has been correctly set up and calibrated.
3. Carefully read the instruction concerning:
  - the use of the chemical product to be applied, especially as regards to the conditions of use and the correct preparation of the dose as shown on the package;
  - operation of the sprayer;

**WARNING: when mixing the chemical products it is always necessary to check that they are physically, chemically and biologically compatible with one another;**
4. During preparation of the mixture, ensure that there are no children, unauthorized persons or animals in the vicinity, or anyone without suitable protection. Always wear protective clothing: gloves, goggles, dust proof mask or helmets, overall working clothes and boot resistant to the chemicals; do not eat, drink or smoke;
5. After preparing of the mixture, carefully wash your hands and face;
6. As soon as packages that contained chemicals products have been emptied they must be washed and rinsed with clean water; the waste water must be poured into the distribution tank (tank for chemicals);
7. The empty packages must be kept inside the premises used for storing chemicals products, until they can handed over the authorized collection service.



## **GENERAL MAINTENANCE**

In order to grant a long life to the sprayer, it is very important to grant particular care to the maintenance.

The sprayer is a machine that has some components running at a very high speed that may accelerate damages if the following important points would not be respected:

- 1) DAILY check if all the bolts and nuts are tight.
- 2) DAILY check if there is any leak and repair it promptly if it is necessary.
- 3) DAILY check the tension of drive belts.
- 4) NEVER run the sprayer without having first checked that all shields are in place.
- 5) BEFORE starting to work verify if all the lubrications have been made according to the instructions.
- 6) DAILY rinse the hydraulic circuit of the sprayer with clean water to avoid sediments which could damage the pump, the valves etc.

Any of the above operations have to be performed only with the motor of the tractor off, a low gear engaged and the parking brake inserted.



## **CLEANING AND MAINTENANCE OF THE MACHINE**

Since the sprayer is always in contact with chemical products, **BE SURE TO USE ALWAYS APPROPRIATE GLOVES, PROTECTIVE CLOTHING AND GOGGLES** to avoid burns or injuries when doing any work on the machine.

1. After any day of work, the sprayer has to be appropriately washed and rinsed inside. When doing this operation be sure of not polluting the environment with the water used for washing.
2. The tank needs to be rinsed inside also when it is necessary to change the type of chemical to be sprayed.
3. At the end of the working season, the machine has to be cleaned throughout and any part has to be checked accurately to verify the need of any repair or maintenance.
4. In areas where the winter may be cold, be sure that all the parts of the sprayer are completely dry to prevent the risk that ice could damage some components, particularly the pump and the valves. To dry out the hoses, blow air with a compressor until all the liquid has gone out. It may be advisable to run some anti freeze in the pump and then drain it out.
5. At the beginning of the new season double-check again the need of any repair, particularly double check if everything is tight and there are no leaks. Verify if the hoses are in good sound conditions. Should you note cracks, replace immediately the hoses with new ones, to prevent the risk of possible blow up when the sprayer will go under pressure.
6. All the tests at the beginning of the season have to be carried with clear water.



## **FILTERS**

The sprayer is equipped with 3 systems of filtering.

1. A basket filter is located under the main cover, the purpose of which is to prevent that any impurity or foreign objects could get into the tank during the operation of filling it with water.
2. A main strainer is located under the tank, connected to the inlet system. The liquid is filtered before getting into the pump, which therefore will work with no risk of damages. This filter is provided with a valve that prevents the return of the liquid and that allows the maintenance of the cartridge also when the tank is full.
3. Each nozzle is provided with one or more filters.

**All the filters are of easy access and easy to clean.**

## **NOZZLES**

The machine is equipped with nozzles which can be either single or double and which can be adjusted to different angles of spray. By turning the nozzle of 90° it shuts off. The double nozzles can spray dilute or concentrate, according to the hole of the tip mounted on each side.

For the nozzles are available many types of ceramic tips with different hole, according to the job to be done.

Tips wear out and, after a certain time, need to be replaced when the delivery starts to be too much or the spray is no longer uniform. Inside the nozzle there is a filter and an anti drip valve. It is recommended to clean frequently the nozzles, filters and anti drip valves to prevent clogging.



## **USE OF THE PUMP**

### **PUMP**

- The pump is built only for liquids foreseen for agricultural use. Running it with any other liquid may damage it as well as other parts of the sprayer. Please refer to the manual of the pump for more information.
- Never exceed the maximum pressure foreseen for the pump.
- The temperature of the liquid has to be between 10° and 30° Centigrade (44° to 86° Fahrenheit).
- Before performing any service to the sprayer or to the pump, be sure to discharge all the pressure by opening the main valve so that the liquid will by-pass to the tank.
- Verify that the liquid runs fluently through the by-pass hose.
- Any part to be replaced such hoses, valves, connectors etc. that are subject to pressure, must be original or the type approved by the manufacturer.
- Never use the pump of the sprayer for running water for human or animal use.



## ***MAINTENANCE OF THE PUMP***

The pump has been tested before getting out from the line of production and therefore it is ready to work. Before starting to work, it is anyhow advisable to check the oil level and all the fittings, as well as if the bolts that hold it to the sprayer are all tight.

The oil lever needs to be verified daily, or more frequently if the sprayer would be working in heavy conditions.

The oil reservoir has never to be completely full. The oil level has to be about at the middle of the check glass.

The oil to be used is of the type anti-foam SAE 20 W 40.

The oil of the pump needs to be replaced at the end of every season or at least every 500 hours of work.

Some pumps are provided with an accumulator to control the pressure, in order to avoid vibrations and pulsation.

The pressure of the accumulator has to be checked periodically with a gauge. The correct pressure setting of the accumulator is shown on the manual of the pump and, as reference, it has to be the 10% of the pressure used for working.

For any more information about the pump refer to the manual of the pump.



## **DIAPHRAGM AND VALVE REPLACEMENT**

### **1. Valve and O-ring Replacement.**

- The constant work and, occasionally debris, can cause the valves to not seal properly or damage the o-ring. To check for this problem, follow these steps: remove the pump manifold (see parts list for your model), with manifold removed, valves can easily be removed and checked for debris or wear.
- To replace valves or O-rings, refer to parts list for appropriate kits.

### **2. Diaphragm Replacement.**

- Drain the oil from the pump by removing drain plug. Rotate the shaft to remove excess oil. Lock back the drain plug.
- Remove the pump manifold as per instruction above on Section 1: Valve and O-ring Replacement.
- Remove pump heads to expose the diaphragms.
- Use a 13 mm box wrench to remove the diaphragm retaining bolt, support washer and diaphragm.
- To replace diaphragms order appropriate repair kit. See parts list.
- Turn the crankshaft to bring the piston to its down stroke and seat the new diaphragm into the sleeve groove. Install retaining washer and tighten nut.
- Refill crankcase with anti-foam SAE 20 W 40 oil. Rotate the shaft to distribute oil and fill to proper level.
- Check the level of the oil that has to be on the middle of the glass.



## **LUBRIFICATION**

### ***DRIVE SHAFT***

Even if the drive shaft is lubricated at the time when it is manufactured, it is advisable to grease it again before the use. The parts that need to be greased are the spiders and the telescoping tubing.

The spiders need to be greased every 8 hours of working and before a long period of inactivity as well as after, because the grease could have dried out.

Particularly when the machines are used in dusty areas, it may be necessary to clean and grease again frequently the telescoping tubing to prevent excessive wear.

The use of some chemicals may also require a particular attention to the lubrication of the drive shafts as the grease could be degraded.

For any other information about the drive shaft, please refer to the manual supplied with it.

THE GREASE USED FOR LUBRICATING THE DRIVE SHAFT IS NLHI GRADE 2.

### ***TRANSMISSION***

The gearbox that engages and disengages the propeller contains oil of the type SAE 90 EP. This oil needs to be changed possibly at the end of every season or, at least every 500 hours of work. The quantity of oil to be used depends from the model of the gearbox. It is therefore necessary to check the oil level on the eye on the side of the gearbox.

### ***MECHANICAL AGITATOR***

If the sprayer is provided with the mechanical agitator, it is necessary to lubricate, every 8 hours, the brass nut which holds the stainless steel shaft of the agitator. The brass nut contains a gasket that prevents leaks along the shaft that needs to be greased periodically. When there is a leak also after the lubrication has been performed, tighten the brass nut slowly. If leak will continue, this means that the gasket needs to be replaced.

For lubricating use grease NLGI grade 2.



## **ROAD CIRCULATION**

Before driving the tractor with the machine on the road, make sure there are no leaks of liquid.

The operator must also ensure that the Rules of the Road in force are complied with, such as, but not only:

- total length of the convoy
- overall width
- axle load
- lifting capacity
- lights and refractive signals
- brake efficiency
- whatever else the Rules of the Road provide for.

**It is strictly forbidden to transport persons, animals or goods on the machine. Operators that are: not of age, without driving license, unskilled and not in good physical or mental health conditions, cannot use the sprayer.**

Farm machines are manufactured for fieldwork. Should they be driven on public roads, then they must be equipped as provided for by Rules in force.

Bear in mind that a 3 point mounted machine, because of its weight, can heavily influence the drive of the tractor. The efficiency of the brakes and the stability of the convoy can become less safe when the tractor is taking a turn. Turns have to be taken with care and at slow speed to avoid the risk of rolling over.



## ***TRANSPORT***

Check if the vehicle's capacity is adequate to the weight of the machine, which is indicated on the serial number plaque riveted on to the frame of the sprayer.

**WARNING:** the weight indicated in the serial nr. label is referred to the machine fully loaded with the liquid.

Adequately fasten the machine and detached parts.

It is advisable to transport the sprayer always with the tank completely empty and clean. Make sure of not spilling anything on the truck and/or on the road.

When loading the sprayer on the truck, trailer or other, make particular attention to the marked lifting points. Lifting the sprayer by hitching other points could cause damages.

Make sure to respect the limits foreseen by the rules of road circulation.

Be careful to lock accurately the machine on the truck or pick-up to avoid unnecessary and/or dangerous movements during the transit. Check all the parts that may get loose and lock them accordingly.



## TROUBLESHOOTING

<b>PROBLEM</b>	<b>CAUSE</b>	<b>REMEDY</b>
The pump does not draw water.	<ul style="list-style-type: none"><li>- One or more valves are seating improperly.</li><li>- Suction line is plugged or collapsed.</li><li>- Clogged strainer.</li></ul>	<ul style="list-style-type: none"><li>- Examine the valve seats and clean them.</li><li>- Examine suction line.</li><li>- Clean strainer.</li></ul>
Pressure gauge fluctuates excessively.	<ul style="list-style-type: none"><li>- The pump is sucking in air through the inlet.</li><li>- Air has not been entirely evacuated from the pump.</li><li>- Locked valves.</li><li>- Leaks from gasket.</li></ul>	<ul style="list-style-type: none"><li>- Examine the suction hose and make sure it is firmly secured.</li><li>- Run the pump with the outlet hose open to evacuate air from the pump.</li><li>- Clean or replace the valves.</li><li>- Clean or replace the gaskets.</li></ul>
The liquid flow is irregular.	<ul style="list-style-type: none"><li>- One or more valves are seating improperly or are damaged.</li></ul>	<ul style="list-style-type: none"><li>- Examine the valve seating and clean or replace them.</li></ul>
Output drops and the pump is noisy.	<ul style="list-style-type: none"><li>- Oil level is too low.</li></ul>	<ul style="list-style-type: none"><li>- Add oil to correct level (half way up the sight tube).</li></ul>
Oil comes out of the discharge port and water in the oil reservoir.	<ul style="list-style-type: none"><li>- One or more diaphragms split.</li></ul>	<ul style="list-style-type: none"><li>- Drain the pump of oil, dismantle the heads and mount new diaphragms. Fill to correct oil level with motor oil (SAE 20W40 - see pump section).</li></ul>
Water is pumped at little or no pressure.	<ul style="list-style-type: none"><li>- The seals on the pressure control valve are worn or damaged.</li></ul>	<ul style="list-style-type: none"><li>- Replace seals and, if necessary, the valve seat and the pin.</li></ul>



## **WARRANTY TERMS**

- The manufacturer guarantees the machine for 12 months from the date of delivery to the final user. Within this period of time the company will be liable to repair or replace, free of charge, any part that would result defective after appropriate examination.
- The misuse or abuse of the machine, any unauthorized modification of it, the use by inexperienced persons, negligence, lack of servicing, the use of not original parts, will void any guarantee right. Same thing for the absence of a sure demonstration of the purchase date.
- All charges for labor and inspection are the buyer's expense, as well are any costs incurred for sending the spare parts.
- All spare parts replaced under guarantee must be returned, carriage pre-paid, to the head office of the manufacturer within a maximum period of 30 days, on pain of invalidity of the guarantee.
- Any repair or replacement carried out or any tampering with the machine during the guarantee period without the authorization of the manufacturer cause the guarantee to become invalid.
- In no case may the buyer claim refunds for damages of any kind, arising in any way as result of use of the machine.
- Any replacement part claimed under guarantee will be invoiced at the time of delivery. The charged sum will then be credited on a later time, once the technical department of the manufacturer will have inspected it and approved the warranty case.



**carrarospray®**

***CARRAROSPRAY***

**O.C.L.L. srl - Via Cornara, 40 - 35010 Villanova (PD) - Italy**

**Tel. +39 049 9220072 r.a. - Fax +39 049 9220951**

**[www.carrarospray.it](http://www.carrarospray.it) - [ocll@carrarospray.it](mailto:ocll@carrarospray.it)**